



T2025[®] STAPLE GUN

ENGLISH

SAFETEY RULES.....	P 2
HOW TO LOAD STAPLES.....	P 3
ABOUT STAPLES.....	P 4
MAINTENANCE & ACCESSORIES.....	P 5

Click Button
to go to page

ESPAÑOL

REGLAS SEGURIDAD.....	P 6
COMO CARGAR LAS GRAPAS.....	P 7
SOBRE LAS GRAPAS.....	P 8
MANTENIMIENTO Y ACCESORIOS.....	P 9

Pulse el botón
para ir a la página

FRANÇAIS

CONSIGNES DE SÉCURITÉ.....	P 10
COMMENT CHARGER DES AGRAFES.....	P 11
AU SUJET DES AGRAFES.....	P 12
ENTRETIEN ET ACCESSOIRES.....	P 13

Bouton-poussoir
pour aller à la page

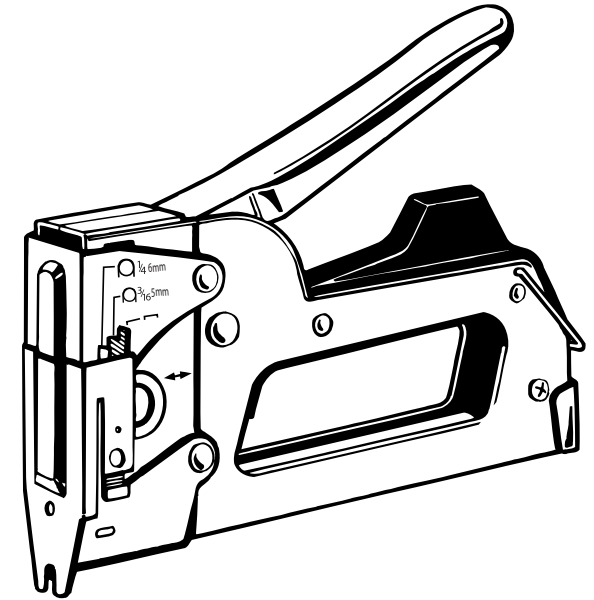



SAFETY RULES

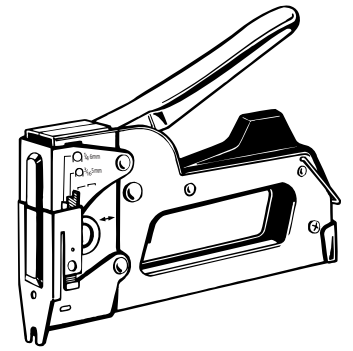

- Always be cautious of potential hazards such as electrical wiring, slippery footing, damp or wet conditions, etc.
- Make sure you know what you are fastening — look for hidden hazards.
- Keep work area clean. Cluttered areas and benches invite accidents.
- Keep children away. All visitors should be kept a safe distance from work area.
- Store idle tools. When not in use, tools should be stored in high or locked-up place — out of reach of children.
- Use safety glasses.
- Do not overreach. Keep proper footing and balance at all times.
- Maintain tools with care. Follow instructions with care.
- For service, use only approved service centers.
- Use only original parts provided by the supplier.
- Stay alert — watch what you are doing. Use common sense.
- Do not staple into electrical wires. Be cautious of wires that may be hidden from view. Disconnect circuits.



BACK TO
INDEX





HOW TO LOAD STAPLES

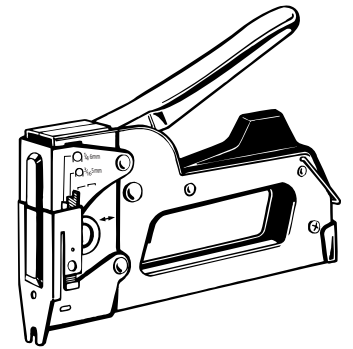

TO LOAD

1. Remove pusher rod from machine.
2. Insert strip of staples.
3. Replace pusher rod.

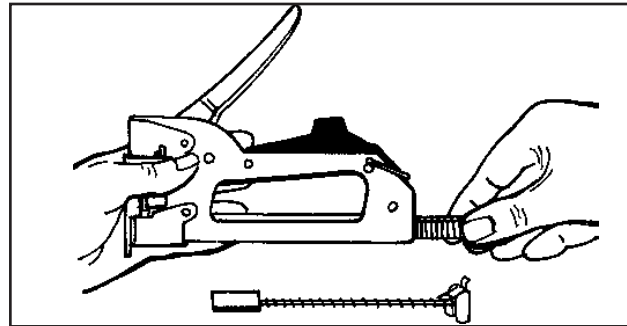

TO CLEAN STAPLE CHANNEL

1. Remove pusher rod A.
2. Remove screw and nut from hole B.
3. Pull down entire inside frame for complete cleaning.

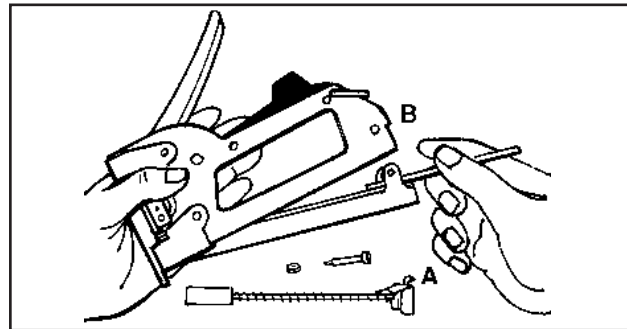

HOW TO DETERMINE STAPLE SHORTAGE FOR REFILL.

1. Press latch to release pusher rod.
2. Lightly push rod forward until it stops. Visible projected part of rod indicates amount of staples remaining in track.

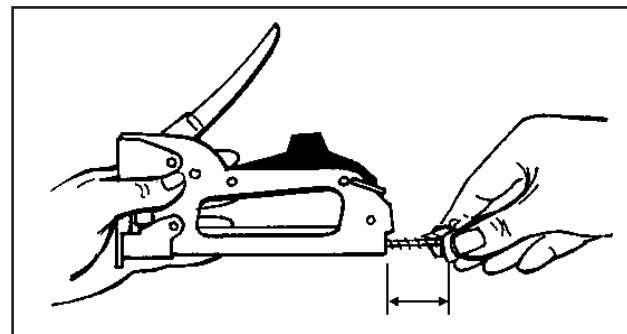

BACK TO
INDEX





ABOUT STAPLES

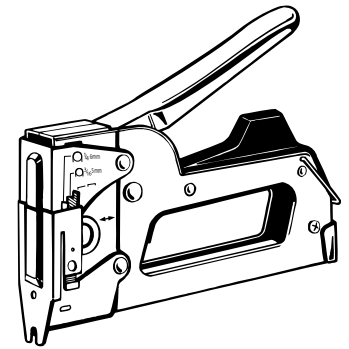

STAPLE PENETRATION

For best penetration with any gun tacker, raise the rear of the gun slightly off the work and bear down on the front end to prevent recoil when operating.

The power spring on the T2025™ will drive well into all ordinary woods. If the wood is very hard and the staple is not driven flush, use a shorter staple size. A shorter staple leg will hold better in hard wood than a long leg in soft wood.

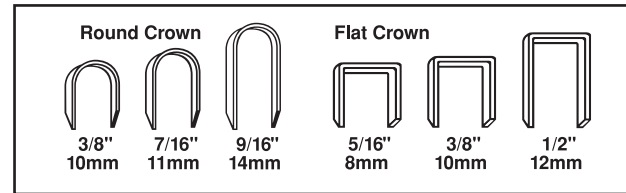

HOW TO DETERMINE PROPER STAPLE LEG SIZE FOR WIRE OR STAPLING

Measure thickness of material to be tacked and allow approximately 3/16" for penetrating wood. A staple that stands away from the material simply means too long a leg length has been used. Try the next shorter leg length for better results.

Congratulations on your purchase of an Arrow® T2025™ Staple Gun Tacker, the "Attacker."

Once you become familiar with its Height Guide*, you will find that the T2025™ "Attacker" is a very versatile tool. Unique to the "Attacker" is its built-in Height Guide and its ability to shoot both round T25™ staples and flat T20™ staples. When the guide is in its lowest position, as indicated by the arrow (Fig. 1), it will staple round or flat wires up to 1/4" 6mm in Dia. Move the "finger-shifter" one notch to the right, and it will safely staple flat or round wire 1/8" 3mm in Dia. with T25™ staples (Fig. 2). Move the "finger-shifter" one more notch to the right, and it will staple the T20 flat crown staples. (Fig. 3).

Round Crown Staple

- Use T25™ Staples Only

Narrow Flat Crown Staple

- Use T20™ Staples Only

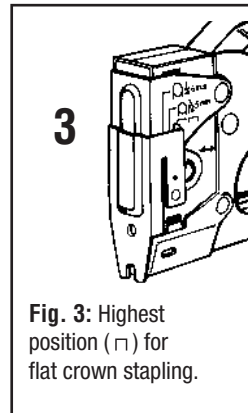
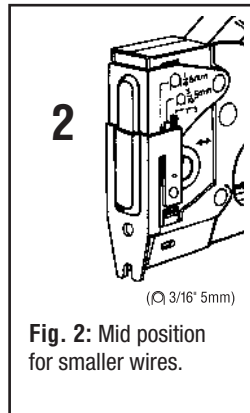
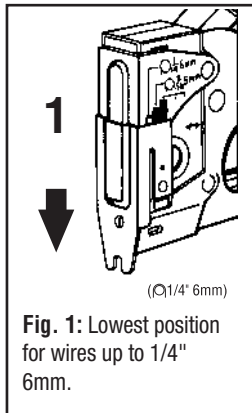

BACK TO INDEX





MAINTENANCE

Arrow Fastener Co., LLC
271 Mayhill Street, Saddle Brook, N.J. 07663
Tel. 201-843-6900

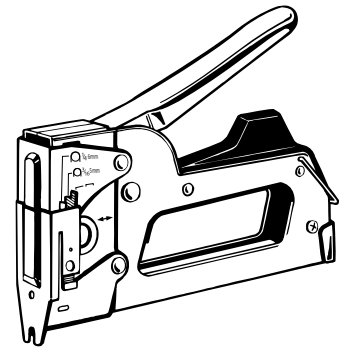

BACK TO
INDEX





REGLAS DE SEGURIDAD

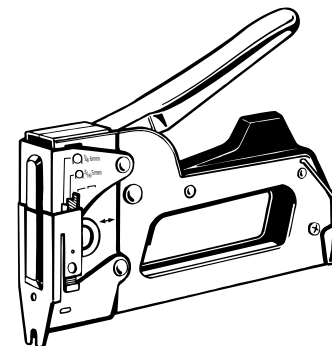

- Siempre debe estar alerta a posibles riesgos tales como cables electricos, pisos resbalosos, condiciones humedas o mojadas, etc.
- Asegúrese de saber lo que esta fijando, esté pendiente de riesgos ocultos.
- Mantenga limpia el área de trabajo. Las áreas y bancas desordenadas propician accidentes.
- Mantenga alejados a los niños. Todo visitante debe permanecer a una distancia del área que no presente peligros.
- Almacene las herramientas que no están en uso. Cuando no se estén usando las herramientas se deben almacenar en un lugar elevado o cerrado con llave, fuera del alcance de los niños.
- Use gafas protectoras.
- No se estire demasiado para alcanzar algo. Siempre debe mantener el debido equilibrio.
- Dé mantenimiento a las herramientas meticulosamente. Obedezca las instrucciones con cuidado.
- Para obtener servicio, comuníquese solamente con los centros de servicio aprobados.
- Use solamente las piezas originales proporcionadas por el proveedor.
- Manténgase alerta, fijese en lo que hace. Use el sentido común.
- No coloque la grapa en cables electricos. Este seguro que no hayan cables que no se alcanzan a ver. Desconecte el circuito.



DE NUEVO
A ÍNDICE





CÓMO CARGAR GRAPAS

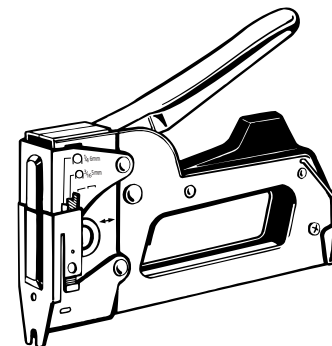

PARA CARGAR

1. Saque la varilla empujadora de la máquina.
2. Meta la franja de grapas.
3. Coloque la varilla de nuevo.

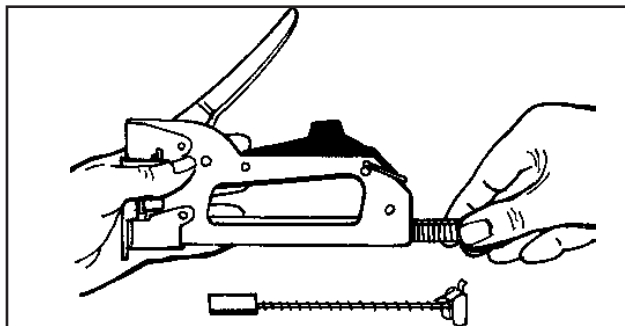

PARA LIMPIAR EL CANAL DE GRAPA

1. Saque la varilla A.
2. Quite la tuerca y el tornillo del agujero B.
3. Saque el canal de grapas para limpiarlo completamente.

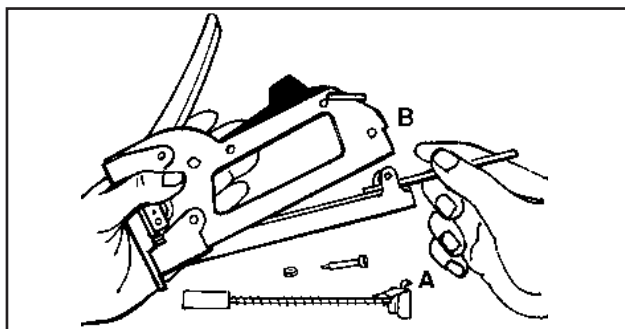

COMO DETERMINAR LA CANTIDAD DE GRAPAS NECESARIAS PARA RELIENAR.

1. Oprima el pestillo para soltar la varia de alimentacion.
2. Empuje la varilla levemente hacia adelante hasta la parrada. Los componentes sobresalientes visibles de la varilla indican la cantidad de grapas que quedan en la carrilera.

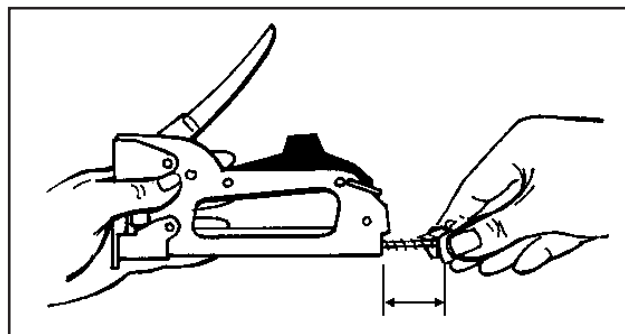

DE NUEVO
A ÍNDICE





PENETRACION DE GRAPA

Para una mejor penetración, levante la parte trasera de la pistola cuando la este operando. La potencia de penetración de la T2025™ es suficiente para el uso en todas las maderas regulares. Si la madera fuere, muy dura y la grapa no penetrara completamente, use una grapa más corta. Una pata de grapa más corta sostendrá mucho mejor en madera dura, que una pata larga en madera suave.

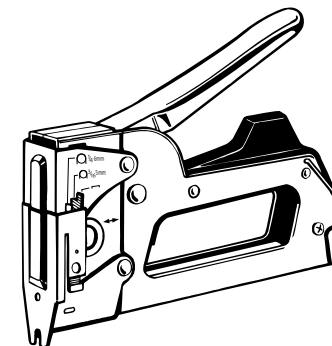
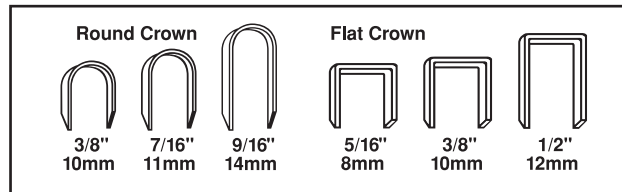

COMO DETERMINAR EL TAMAÑO DE PATA DE GRAPA

Mida el grueso del material que va a clavar y ceda aproximadamente 3/16" para la penetración. Una grapa que sobresalga del material, significa que una pata muy larga ha sido usada. Trate el tamaño más corto para los mejores resultados.

Congradulaciones para su compra do una grapadora de Arrow® T2025™ la engrapadora "Attacker."

Una vez familiar con ci guia de distancia se va a enterar de que la engrapadora T2025™ es un heramiento de muchos usos. Lo unico de la engrapadora "Attacker" es su guia de distancia* incorporada y la posibilidad de que pueda utilizar con ella dos tipos de grapas: las redondas T25™ y las planas T20. Cuando el guia esta en la posicion mas baja, como indicado con la fecha (fig. 1), pueda sujetar cordones o cables redondos o planos hasta 6mm. Si mueva "regulador de dedo" un grado hacia la derecha, pueda sujetar con las grapas T25™ securamente cables redondos o planos de hasta 3mm (fig. 2). Si mueva el "regulador de dedo" aun un grado mas hacia la derecha, pueda utilizar las grapas planas T20™ (fig. 3).

Round Crown Staple

- Grapas Redondas Solo Para las Grapas T25™

Narrow Flat Crown Staple

- Grapas Planas, Estrachas Solo Para las Grapas T20™

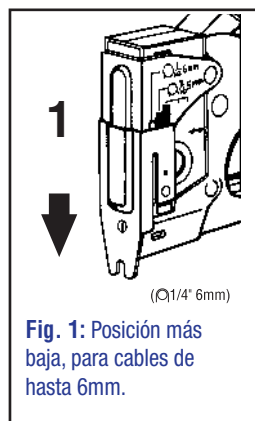

Fig. 1: Posición más baja, para cables de hasta 6mm.

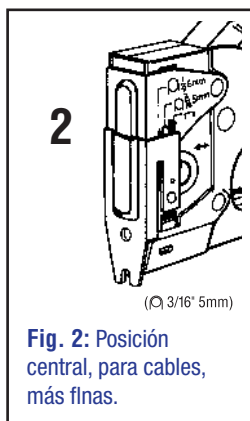

Fig. 2: Posición central, para cables, más finas.

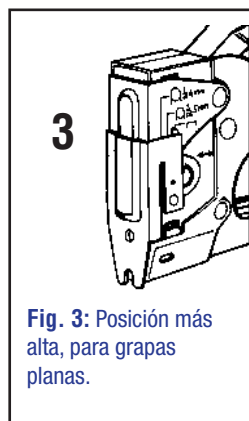

Fig. 3: Posición más alta, para grapas planas.

DE NUEVO A ÍNDICE





MAINTENANCE

Arrow Fastener Co., LLC
271 Mayhill Street, Saddle Brook, N.J. 07663
Tel. 201-843-6900

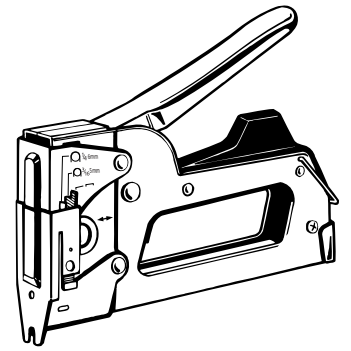

DE NUEVO
A ÍNDICE





INSTRUCTIONS DE SÉCURITÉ

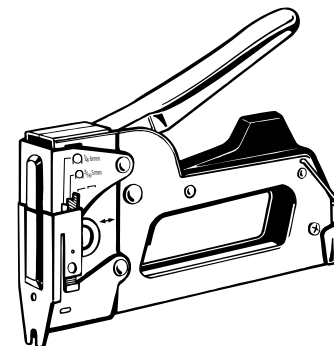

- Soyez toujours vigilant à cause de possibles sources de danger tels que les câblages électriques, les sols glissants, l'humidité, etc.
- Assurez-vous de bien connaître le produit que vous fixez, cherchez les dangers cachés.
- Veillez à ce que l'aire de travail soit propre. Les locaux et plans de travail encombrés sont propices aux accidents.
- Veillez à ce que les enfants restent à l'écart. Tous les visiteurs doivent se tenir à une distance raisonnable des zones de travail.
- Rangez les outils qui ne sont pas en usage dans un endroit sûr, en hauteur ou sous clé, hors de la portée des enfants.
- Portez des lunettes de sécurité.
- N'essayez pas d'atteindre des points éloignés. Conservez votre équilibre en tout temps.
- Veillez à soigneusement entretenir votre outillage. Respectez scrupuleusement les instructions à cet effet.
- En cas de besoin faites appel exclusivement à un centre de dépannage agréé.
- Utilisez exclusivement des pièces d'origine disponibles chez votre fournisseur.
- Restez vigilant – donnez toute votre attention à votre travail. Faites preuve bon sens.
- Precaution: Avant d'agrafer, assurez-vous que le câble se trouve bien dans l'empreinte du bec de l'agrafeuse ceci afin d'éviter d'endommager les fils conducteurs. Attention: Lors de la pose du câble, bien vérifier que celui-ci ne soit pas sous tension.



DE NOUVEAU
À L'INDEX





COMMENT CHARGER DES AGRAFES

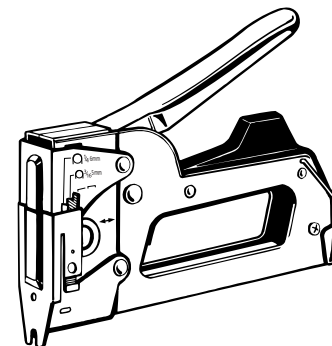

POUR CHARGER

1. Enlevez la tige de poussée de la machine.
2. Insérez un ruban de broches.
3. Retournez la tige à sa place.

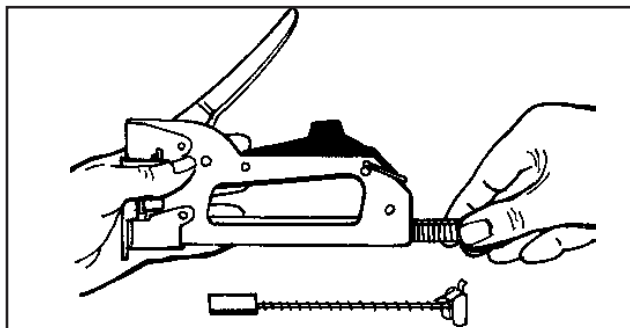

POUR NETTOYER LE CONDUIT DES BROCHES

1. Enlevez la tige A.
2. Enlevez la vis et l'écrou du trou B.
3. Tirez à bas toute l'armature intérieure pour un nettoyage complet.

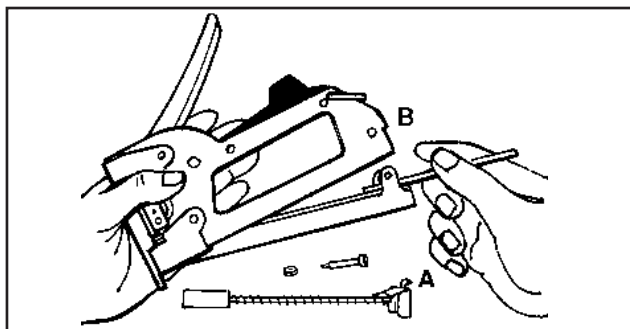

COMMENT DETERMINER LA QUANTITÉ DE BROCHES NECESSAIRE POUR REMPLISSAGE.

1. Pressez le loquet pour relacher le poussoir.
2. Poussez la tige légèrement en avant, jusqu'à l'arrêt. Les composants saillants visibles de la tige indiquent la quantité d'agrafes qui restent dans a voie.

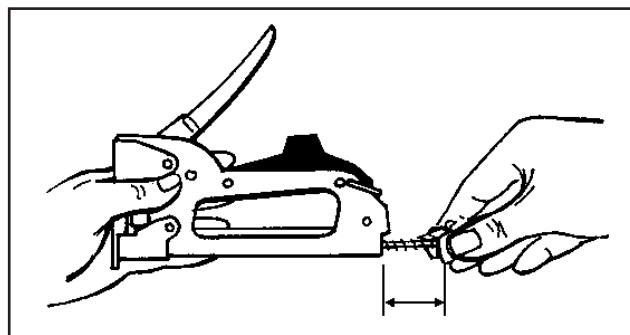

DE NOUVEAU
À L'INDEX





AU SUJET DES AGRAFES

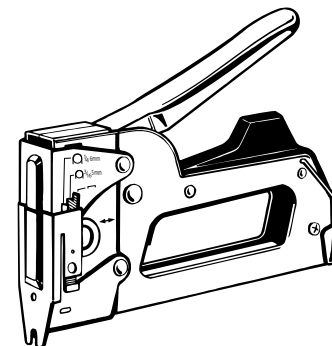

PENETRATION DES BROCHES

Afin d'obtenir la meilleure pénétration possible avec un pistolet brocheur quelconque, relevez légèrement l'arrière du pistolet audessus du material et apprêtez sur l'extrémité avant pour empêcher un recul du pistolet pendant le travail. Le ressort de poussée du T2025™ entrera facilement dans toutes les especes de bois courantes. Si le bois est très dur et la broche n'entre pas à fleur du bois, changez pour une broche plus courte. Dans le bois dur, une broche plus courte aura davantage de retenue qu'une broche plus longue dans du bois moins dur.

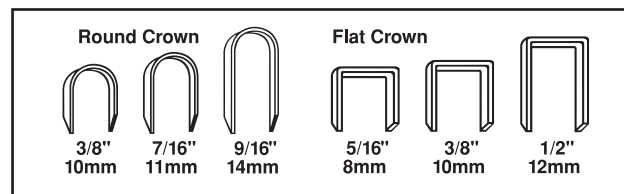

COMMENT FAIRE POUR DETERMINER LA PATTE DE LA BROCHE DE LONGUEUR APPROPRIEE

Mesurez la grosseur du material a clouer et ajoutez 3/16" pour pénétrer dans le bois. Lorsqu'une broche ressort du material, une broche à patte trop longue a été usée. Essayez la grandeur suivante plus courte, pour obtenir des resultats meilleurs.

Nous vous félicitons d'avoir acheté une agrafeuse à main Arrow® T2025™ L'Attacker.

Des que vous vous serez familiarisé avec l'usage de son guidage d'hauteur*, vous verrez que l'Attacker T2025™ est un outil aux usages très variables. L'Attacker se distingue par son guidage d'hauteur encastré et par sa capacité de manier autant les agrafes arrondies T25™ que les agrafes aplaties T20™. Quand le guidage se trouve dans sa position inférieure, comme l'indique la flèche (fig. 1), vous pouvez fixer les fils et cables ronds ou plats d'un diamètre jusqu'à 6mm. Poussez le bouton d'un cran vers la droite, et vous pouvez fixer des fils et câbles plats ou ronds d'un diamètre de 3mm avec les agrafes T25™ (fig. 2). Poussez le bouton encore d'un cran de plus vers la droite et vous pouvez travailler avec les agrafes aplaties T20™ (fig. 3).

Round Crown Staple

- Agrafes Arrondies Usage D'Agrafes T25™ Uniquement

Narrow Flat Crown Staple

- Agrafes Fines Aplaties Usage D'Agrafes T20™ Uniquement.

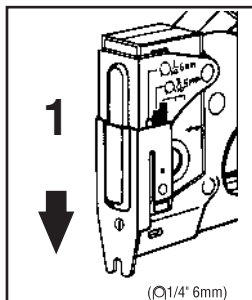

Fig 1: Position inférieure (jusqu'à 6mm) pour fils et câbles d'un diamètre jusqu'à 6mm.

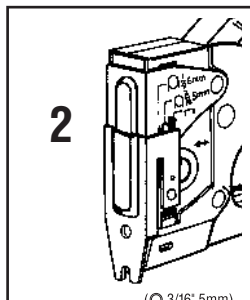

Fig. 2: Position intermédiaire pour fixer des fils et câbles plus fins.

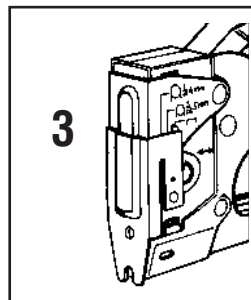

Fig. 3: Position supérieure pour l'usage d'agrafes aplaties.

DE NOUVEAU
À L'INDEX





MAINTENANCE

Arrow Fastener Co., LLC
271 Mayhill Street, Saddle Brook, N.J. 07663
Tel. 201-843-6900

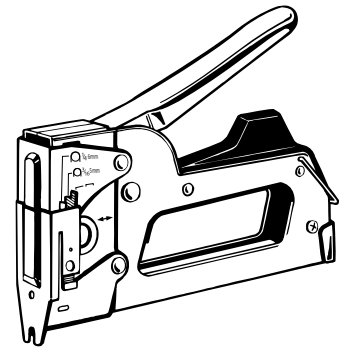

DE NOUVEAU
À L'INDEX

